



**Zaoshang**  
**Engineering Co. LTD**

**30** YEARS, WE ARE MORE  
PROFESSIONAL



Please Contact Us

Name: King Guo

Tel/WhatsApp: +86 15610891097

Email: [king@hbzs-glass.com](mailto:king@hbzs-glass.com)

# Perfume Bottle

G-4-30 G-4-50 G-4-100



W3686 W3753 W1768



XB045 XB043



HYD554 HY198



F1002 W2317 W2316 F1001

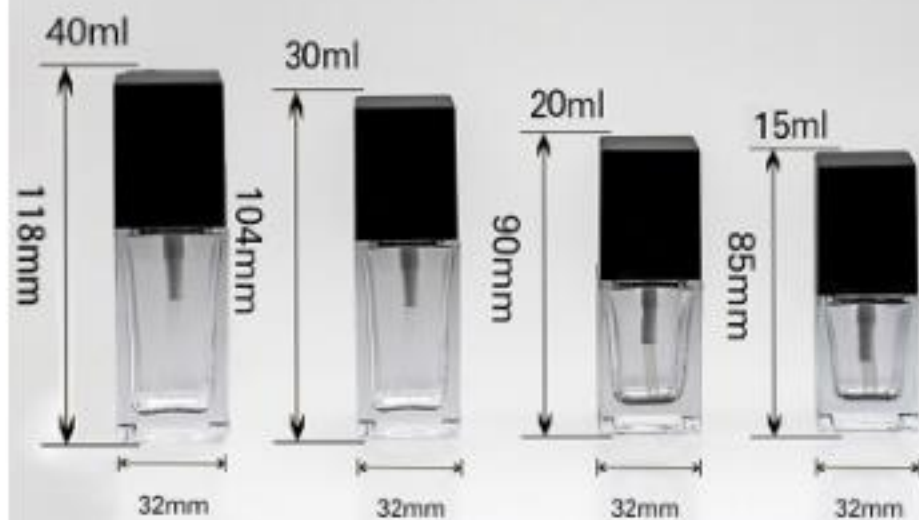

HY009 D1614



HYD232

GSH-011

HYD10763

XB079

HYD783

HYD872

W8567

HYD1410

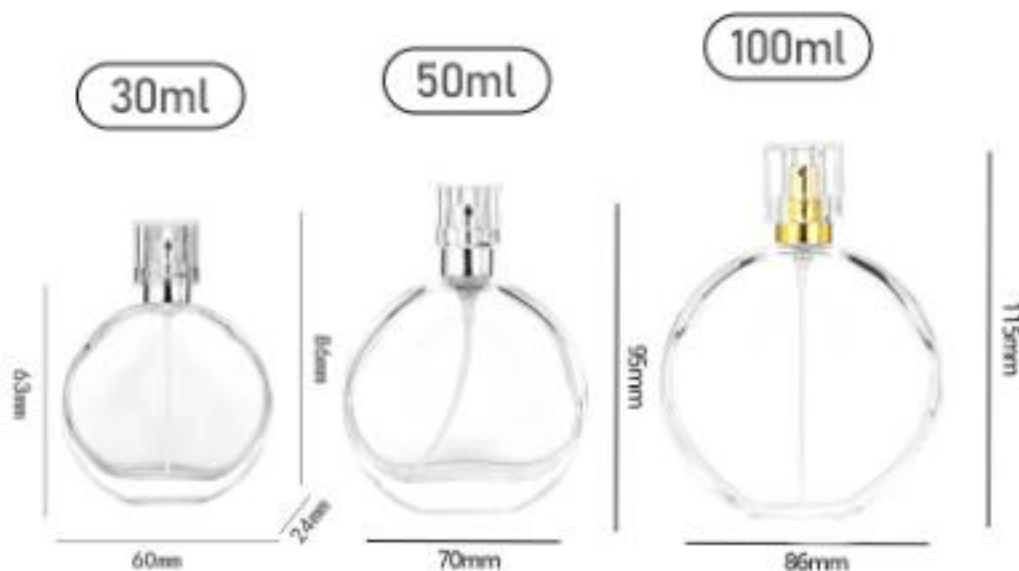

DU-8

DU-9

XB087

HYD223

XB219

HYD-080哑黑 HYD649哑黑 GSH-361哑黑

30ml

50ml

100ml



30ml

50ml

100ml



30ml

100ml

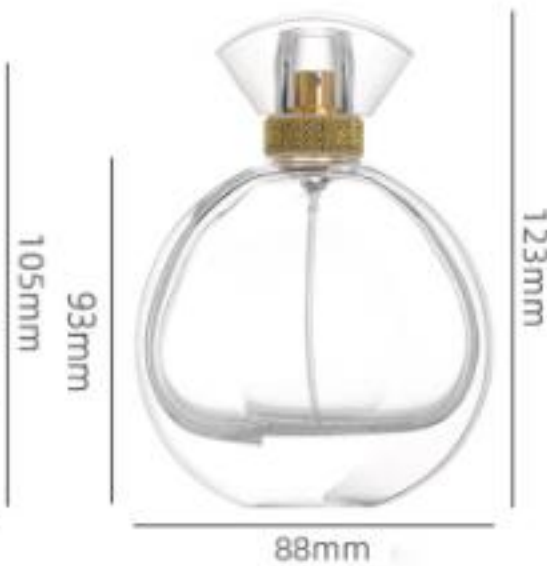

HYD953

70ml



HYD953红

70ml



HYD057

25ml



HYD1751

50ml



HYD鸦片

80ml



HYD223

30ml



XB219

100ml



HYD1036

30ml



HYD1034

100ml



HYD1066

30ml



HYD017

50ml



GSH279

100ml



XB115

50ml



XB114

100ml



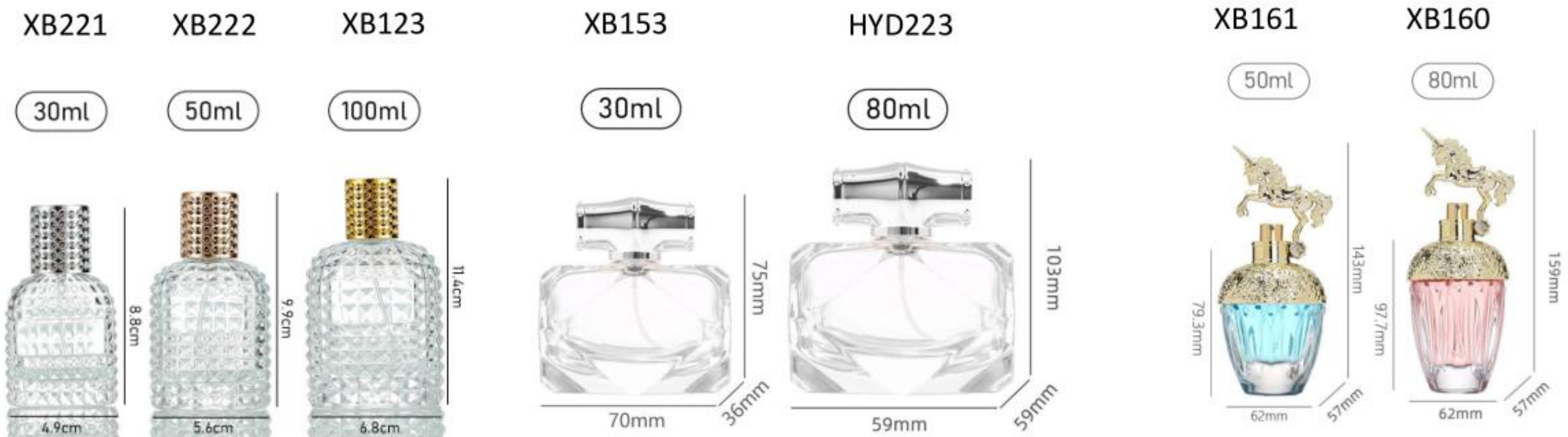

XB147



XB-207



GSH338



HYD41渐变 HYD2427渐变 HYD854渐变



HYD-64



HYD027



A1882



XB149



HYD836



XB149哑黑



HYD836哑黑



XB149渐变



HYD836渐变



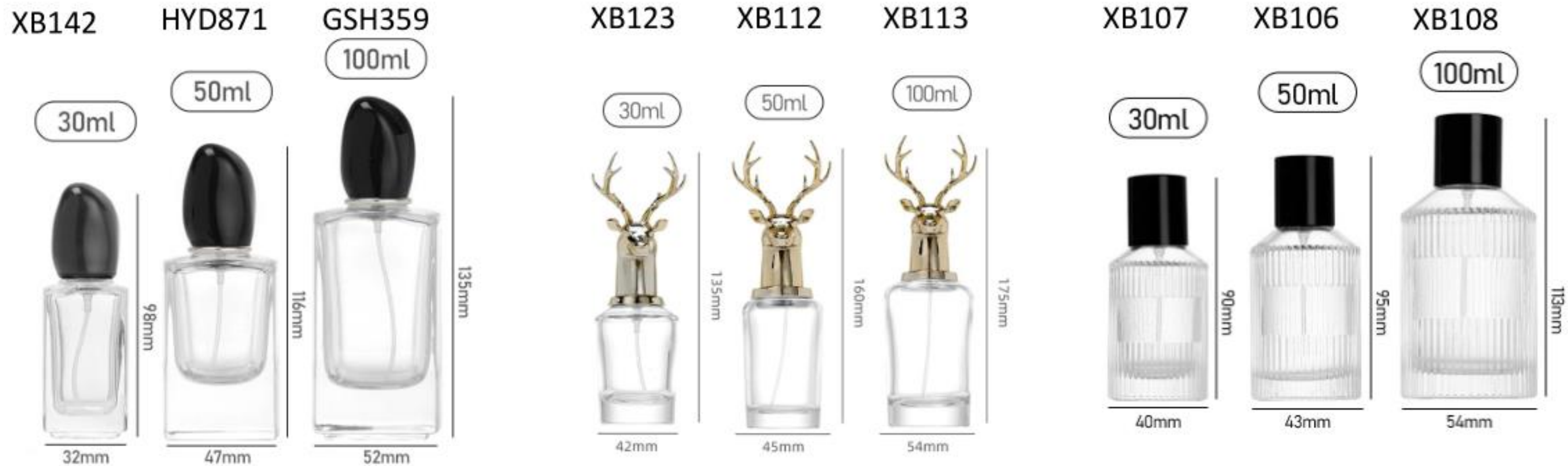



**XB116**

30ml



50mm

70mm

**XB130**

50ml



56mm

81mm

**XB129**

100ml



66mm

92mm

**XB137**

30ml



44mm

87mm

**XB096**

50ml



51mm

97mm

**XB139**

100ml



60mm

111mm

**HYD10988**

20ml



41mm

74mm

**HYD36**

30ml



46mm

82mm

**HYD3625**

50ml



54mm

97mm

**XNE**

100ml



66mm

112mm

HYD2174

50ml



HYD1260

100ml



HYD503

70ml



HYD-DZS

70ml



XB173

100ml



HYD-1047

100ml



HYD-3940

50ml



HYD-4516

50ml



HYDN49-1

100ml



# Water Bottle

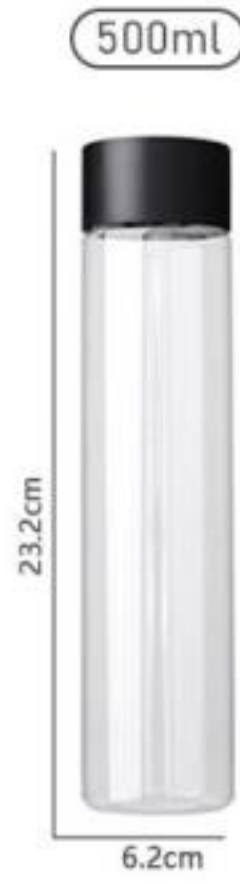

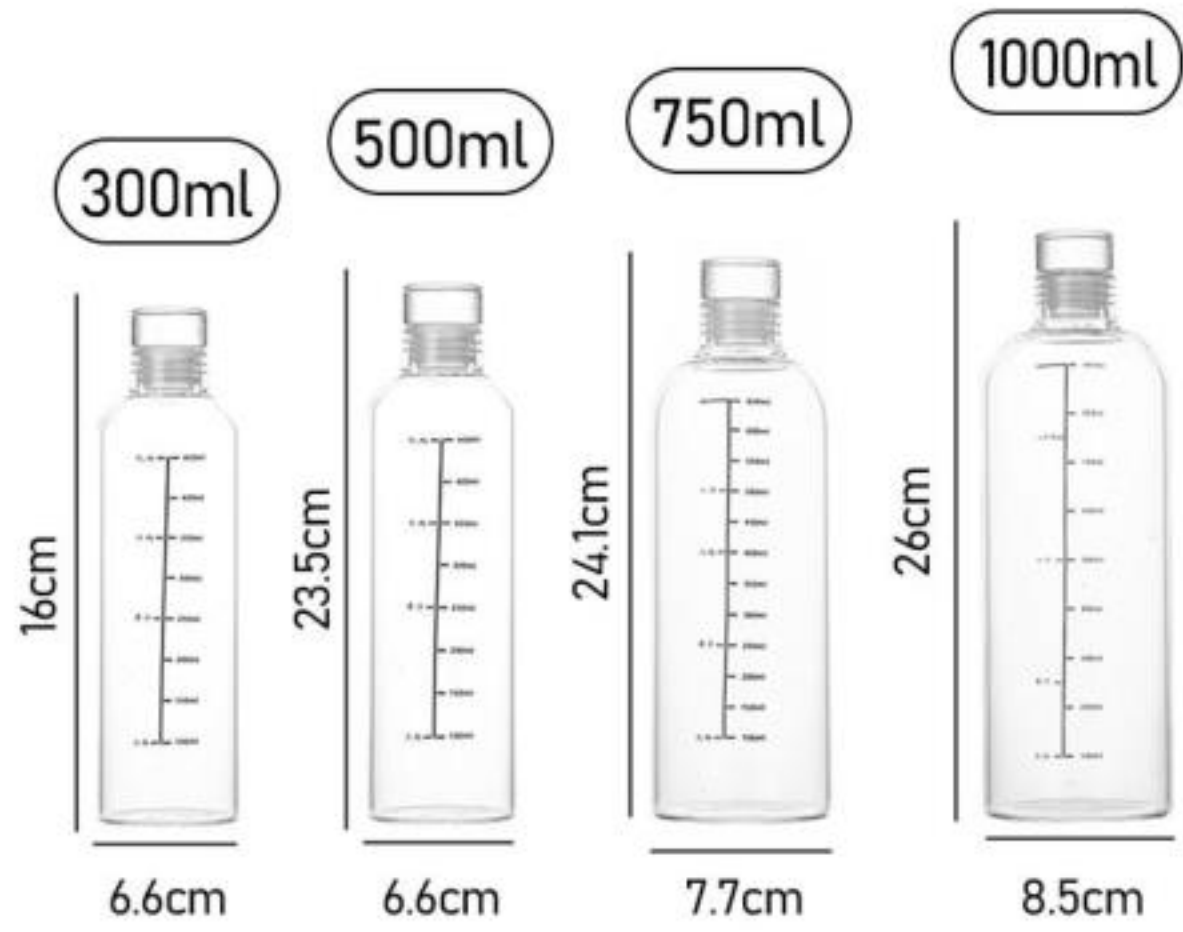

# Cooking Oil Bottle

100ml



14CM

4.1CM

250ml



21.5CM

4.8CM

500ml



26.5CM

5.8CM

750ml



30.5CM

6.5CM

1000ml



30.5CM

7.5CM

100ml



15CM

4.5CM

250ml



23.3CM

5CM

500ml



27.6CM

6CM

750ml



30.8CM

7CM

1000ml



32.5CM

7.8CM



350ml

17.6cm

8.9cm 3.0cm



630ml

23.4cm

8.9cm 3.0cm



14CM

4.1CM



21.5CM

4.8CM



26.5CM

5.8CM



30.5CM

6.5CM



30.5CM

7.5CM



15CM

4.5CM



23.3CM

5CM



27.6CM

6CM



30.8CM

7CM



32.5CM

7.8CM



300ML

20CM

6.5CM



300ML

21CM

6.5CM



14CM

4.1CM



21.5CM

4.8CM



26.5CM

5.8CM



30.5CM

6.5CM



30.5CM

7.5CM



15CM

4.5CM



23.3CM

5CM



27.6CM

6CM



30.8CM

7CM



32.5CM

7.8CM

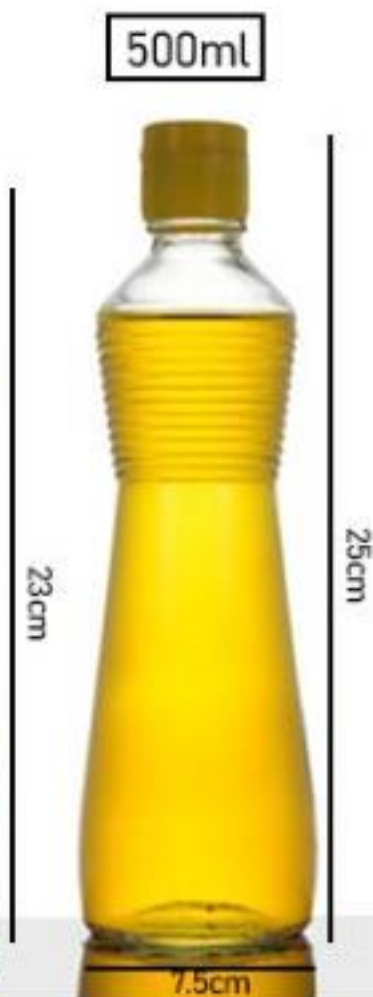





# Grinder & Spice Bottle



# Spice Shaker Bottle





# Bird's Nest Jar





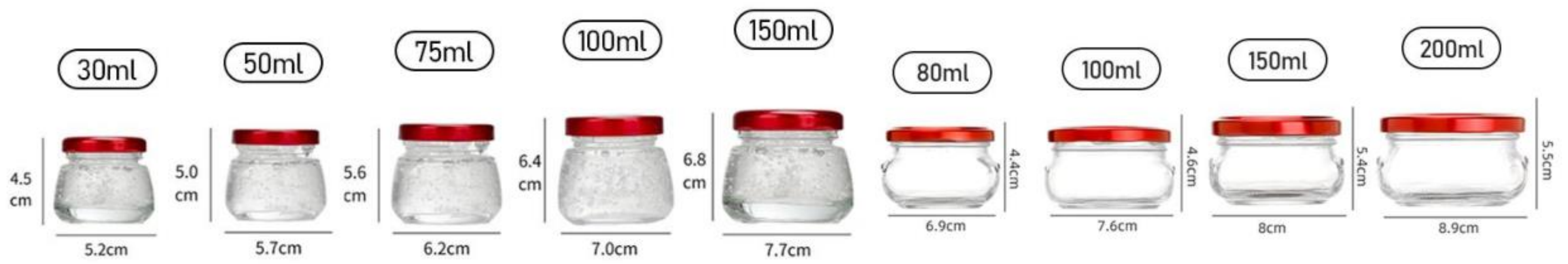

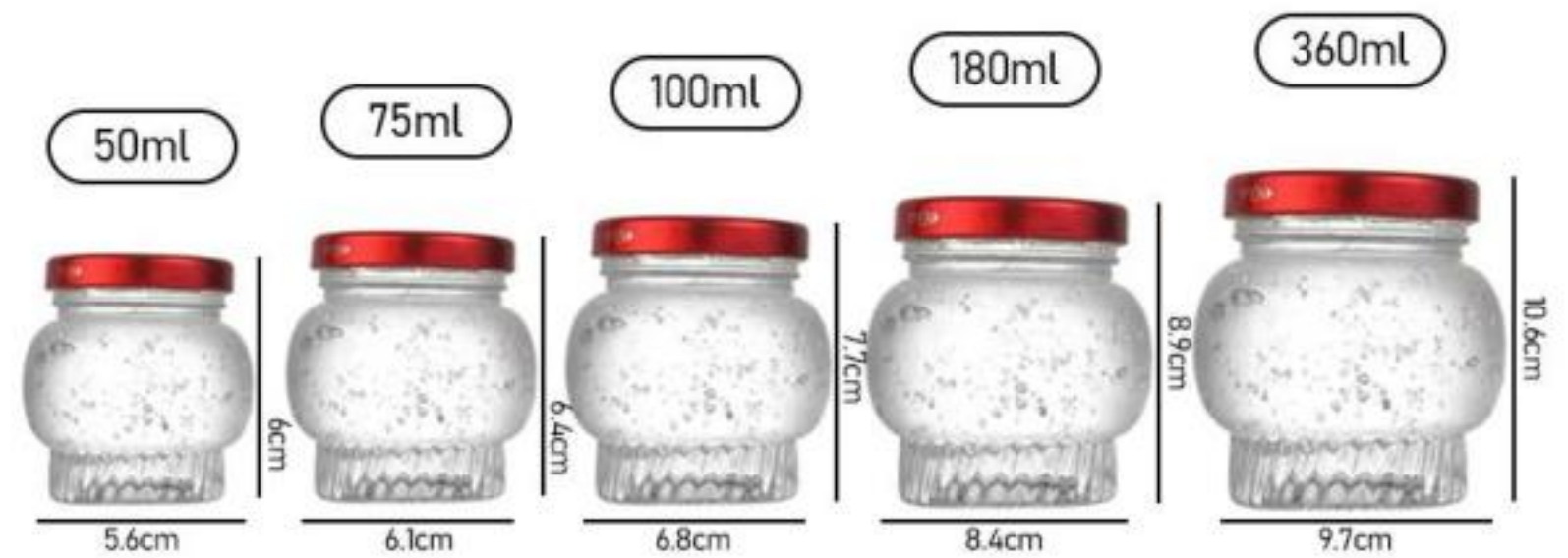
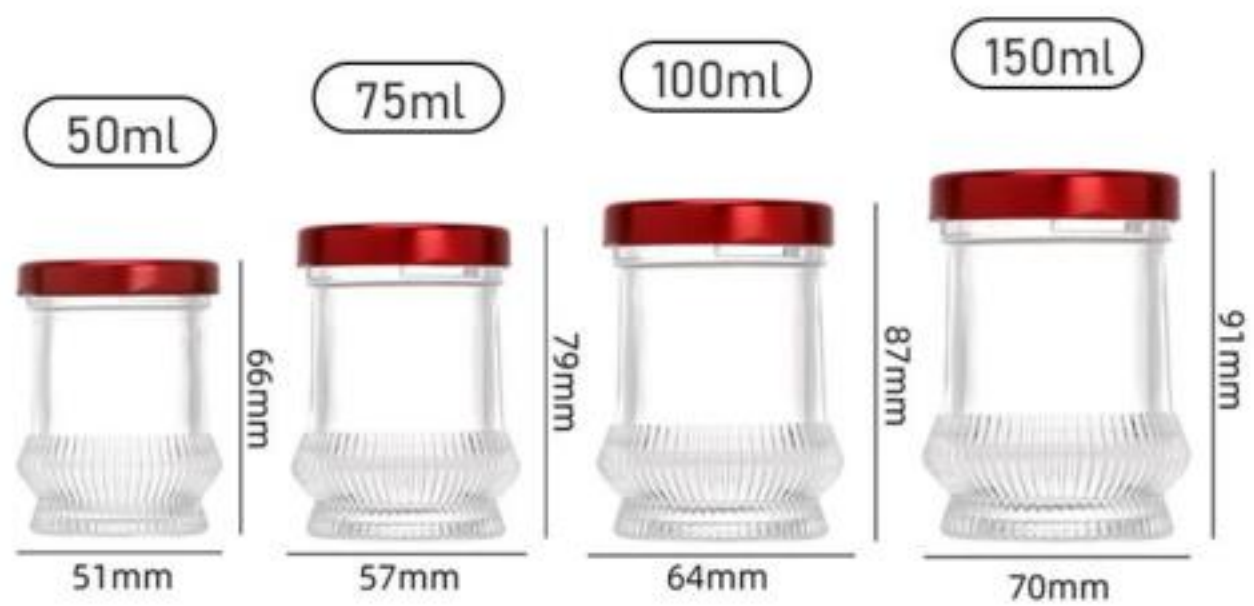
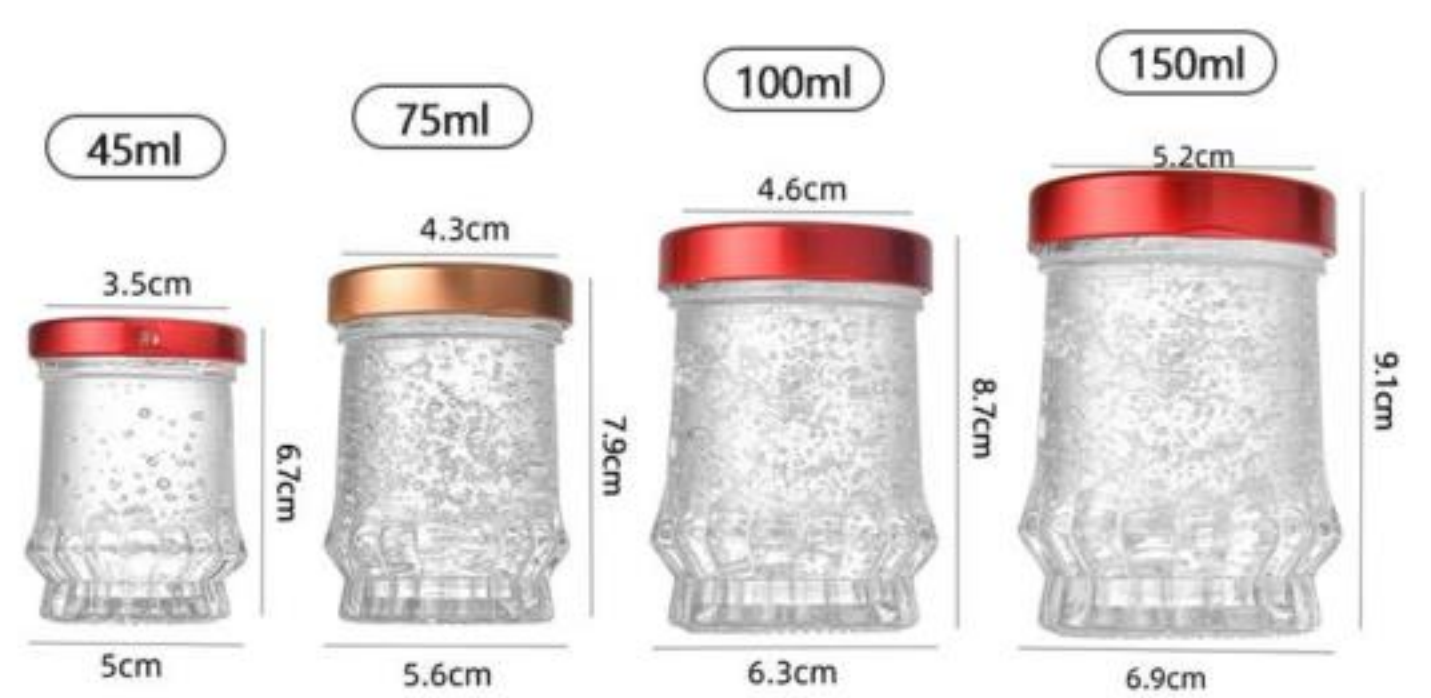



# Essential Oil Bottles

# Essential Oil Bottles

## Original Colour



茶色 透明色 绿色 蓝色



玻璃管统一直径为：7mm

温馨提示：所有尺寸均为手工测量，误差0.1-2mm，请以实物为准



## Frosted



5ML 10ML 15ML 20ML 30ML 50ML 100ML



5ML 10ML 15ML 20ML 30ML 50ML 100ML



5ML 10ML 15ML 20ML 30ML 50ML 100ML



Capacity	QTY/CTN	Carton Size	GW KG	Bottle dimension
5ml	765 pcs	410*315*170	17.4	H:5cm D:2.1cm W:26g
10ml	768 pcs	450*290*270	19.8	H:5.8cm D:2.5cm W:28g
15ml	468 pcs	430*280*240	14.2	H:6.5cm D:2.9cm W:31g
20ml	468 pcs	420*320*240	17.8	H:7.1cm D:2.9cm W:33g
30ml	330 pcs	400*310*270	15.8	H:7.9cm D:3.2cm W:47g
50ml	264 pcs	460*290*290	17.4	H:9.2cm D:3.7cm W:61g
100ml	140 pcs	490*300*250	13.4	H:11.2cm D:4.4cm W:93g

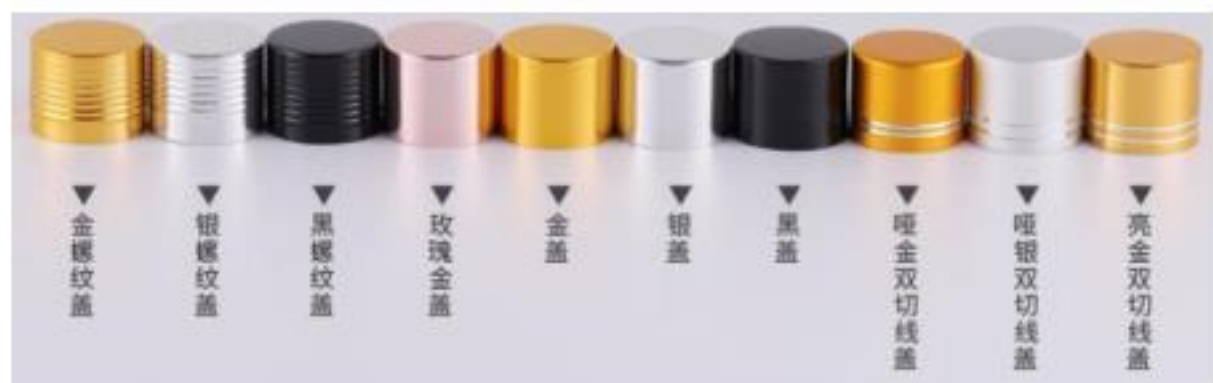
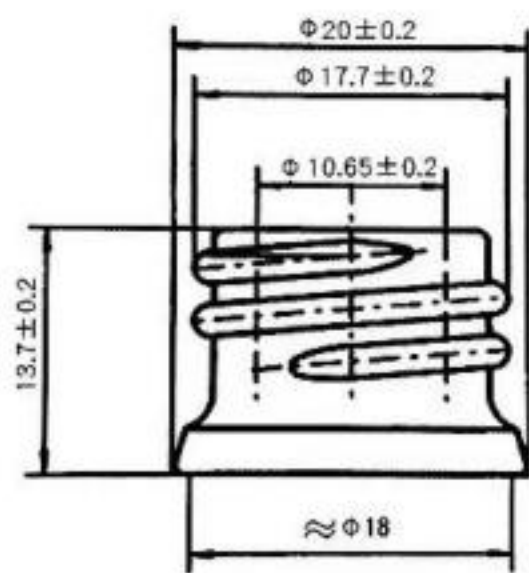



# HU LU



参数	瓶身全高	直径	周长
10ML	56MM	32MM	100MM
20ML	78MM	39MM	122MM
30ML	83MM	42MM	132MM
50ML	95MM	49MM	153MM
100ML	115MM	60MM	188MM



参 数	瓶身全高	瓶子直径	瓶子周长	印刷高度
10ML	71mm	30mm	30mm	45mm
20ML	76mm	38mm	119mm	50mm
30ML	86mm	41mm	129mm	60mm
50ML	102mm	46mm	144mm	76mm
100ML	128mm	56mm	176mm	102mm







# Lotion Bottle



# Foundation

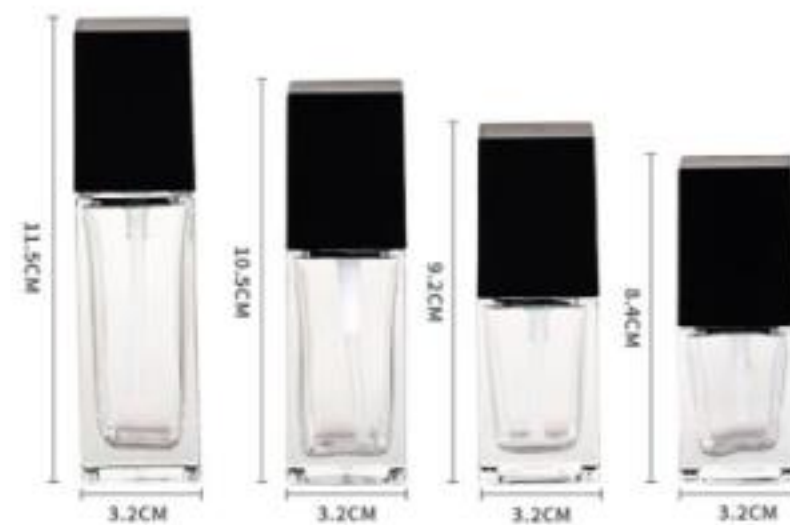

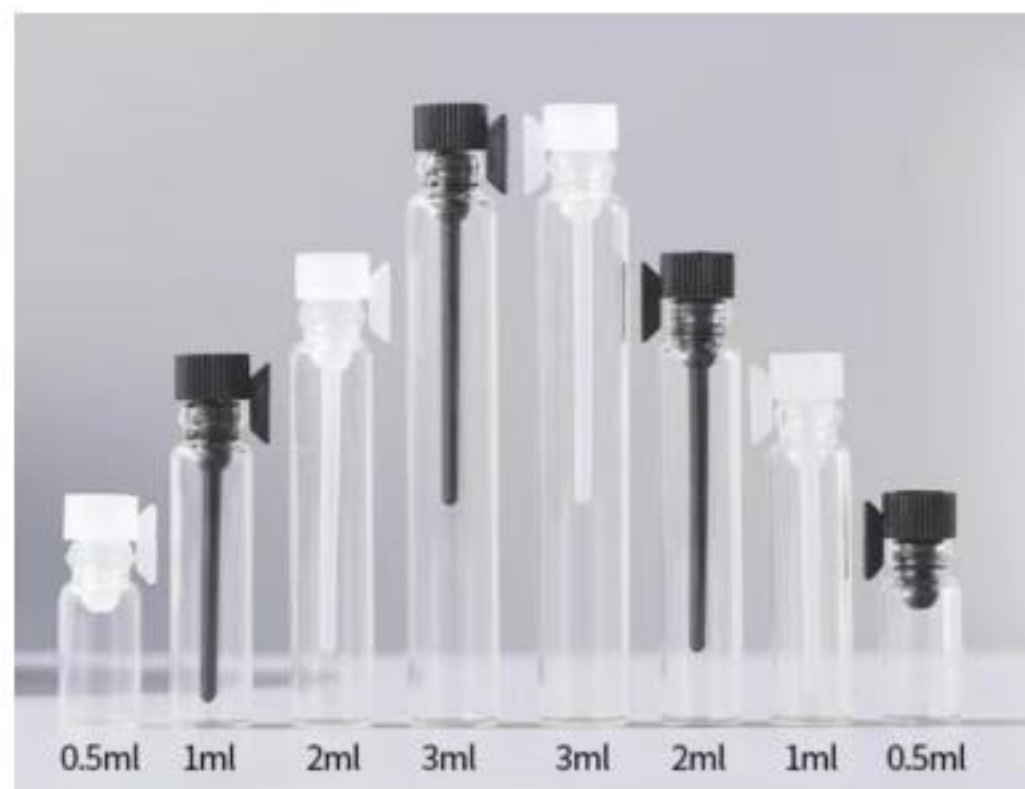

Plug 1ML 25000pcs 46\*30\*25 7KG  
 Plug 2ML 25000pcs 46\*30\*25 7.15KG



容量	含盖高度	直径	裸瓶高	重量	装箱数
5ml	6.3cm	2cm	4.85cm	17.5g	648只 (216x3)
10ml	8.6cm	2cm	7.2cm	72g	600只 (156x4)

## 产品参数

PRODUCT PARAMETERS

参 数	瓶身全高	瓶身直径	周长	可印刷高度
0.5ML	25mm	9mm	30mm	10mm
1ML	40mm	9mm	30mm	25mm
2ML	51mm	9mm	30mm	35mm
3ML	67mm	9mm	30mm	50mm

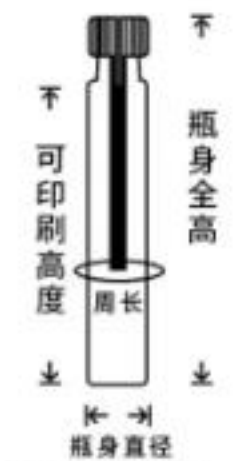

0.5ML 20000pcs 48\*35\*24 21.5Kg  
 1ML 10000pcs 48\*35\*21 17.3Kg  
 2ML 10000pcs 48\*35\*27 21.9Kg  
 3ML 5000pcs 43\*30\*28 16.3Kg

注：数据仅供参考请以实测为准，不承担任何因数据产生的误差所造成的损失

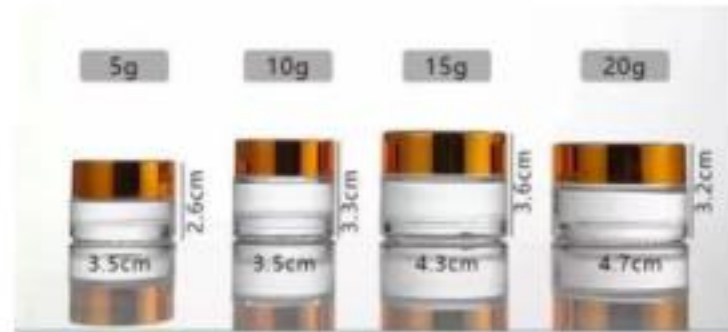
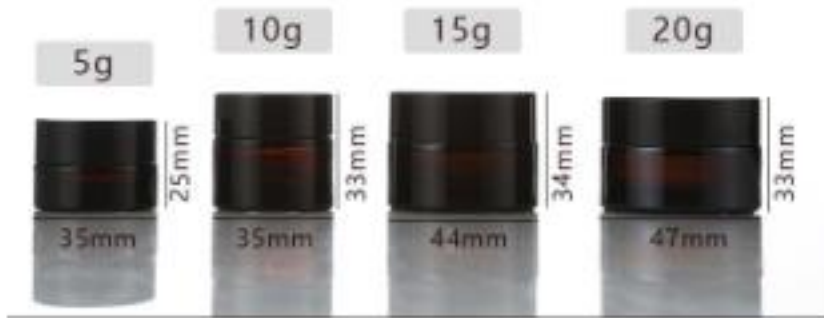

# BOSTON



规格	15ml 茶波	30ml 茶波	60ml 茶波	120ml 茶波	240ml 茶波	480ml 茶波
裸瓶尺寸/mm	68.26*25	78.58*32.8	93.66*38.6	112.73*48.82	138.1*60.33	168.7*74.6
裸瓶重量/g	25.5	44	58	108	175	255
口径/mm	18mm	20mm	20mm	22mm	28mm	28mm
满瓶容量/ml	14.2	31.3	60.8	120	230	480
满口容量/ml	16.4	36.2	63.8	125.7	250	500
箱规/cm	41.5*30*22.5	43*32*25	41.5*29*30	44*37*25	52*33*29	49.4*33.7*35
箱数/只	540	360	240	128	96	60
箱重/kg	14	16	14	14	17	16





30ml 60ml 100ml 125ml 150ml 200ml 250ml 300ml 500ml





容量	高度	内径	直径
20ML	83MM	14MM	26MM
30ML	89MM	15MM	30MM
50ML	107MM	20MM	35MM
100ML	123MM	20MM	44MM
125ML	145MM	20MM	46MM

